

## FEATURES

- Low Profile (1mm) ThinSOT™ Package
- No Blocking Diode Required
- No Sense Resistor Required
- 1% Accurate Preset Voltages: 4.1V or 4.2V
- Charge Current Monitor Output for Charge Termination
- Programmable Charge Current: 200mA to 700mA
- Automatic Sleep Mode with Input Supply Removal
- Manual Shutdown
- Negligible Battery Drain Current in Shutdown
- Undervoltage Lockout
- Self Protection for Overcurrent/Overtemperature

## APPLICATIONS

- Cellular Telephones
- Handheld Computers
- Digital Cameras
- Charging Docks and Cradles
- Low Cost and Small Size Chargers
- Programmable Current Sources

LT, LT, LTC, LTM, Linear Technology and the Linear logo are registered trademarks and ThinSOT is a trademark of Linear Technology Corporation. All other trademarks are the property of their respective owners.

## DESCRIPTION

The LTC<sup>®</sup>1734 is a low cost, single cell, constant-current/constant-voltage Li-Ion battery charger controller. When combined with a few external components, the TSOT-23 package forms a very small, low cost charger for single cell lithium-ion batteries.

The LTC1734 is available in 4.1V and 4.2V versions with 1% accuracy. Constant current is programmed using a single external resistor between the PROG pin and ground. Manual shutdown is accomplished by floating the program resistor while removing input power automatically puts the LTC1734 into a sleep mode. Both the shutdown and sleep modes drain near zero current from the battery.

Charge current can be monitored via the voltage on the PROG pin allowing a microcontroller or ADC to read the current and determine when to terminate the charge cycle. The output driver is both current limited and thermally protected to prevent the LTC1734 from operating outside of safe limits. No external blocking diode is required.

The LTC1734 can also function as a general purpose current source or as a current source for charging nickel-cadmium (NiCd) and nickel-metal-hydride (NiMH) batteries using external termination.

## TYPICAL APPLICATION

300mA Li-Ion Battery Charger

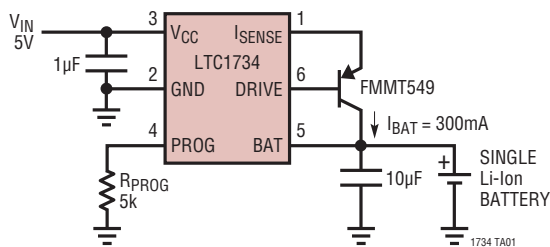

PROG Pin Indicates Charge Status

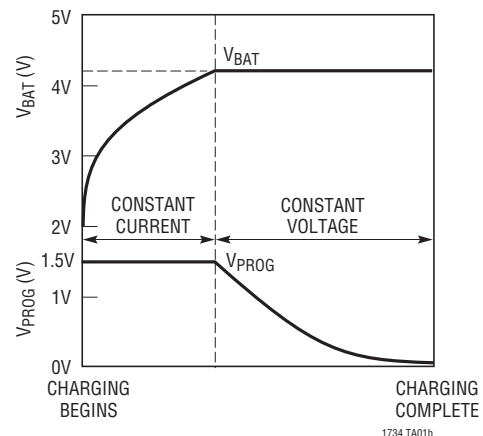

# LTC1734

## ABSOLUTE MAXIMUM RATINGS

(Note 1)

Supply Voltage ( $V_{CC}$ )	-0.3V to 9V
Input Voltage (BAT, PROG)	-0.3V to ( $V_{CC} + 0.3V$ )
Output Voltage (DRIVE)	-0.3V to ( $V_{CC} + 0.3V$ )
Output Current ( $I_{SENSE}$ )	-900mA
Short-Circuit Duration (DRIVE)	Indefinite
Junction Temperature	125°C
Operating Ambient Temperature Range	
(Note 2)	-40°C to 85°C
Operating Junction Temperature (Note 2)	100°C
Storage Temperature Range	-65°C to 150°C
Lead Temperature (Soldering, 10 sec)	300°C

## PIN CONFIGURATION

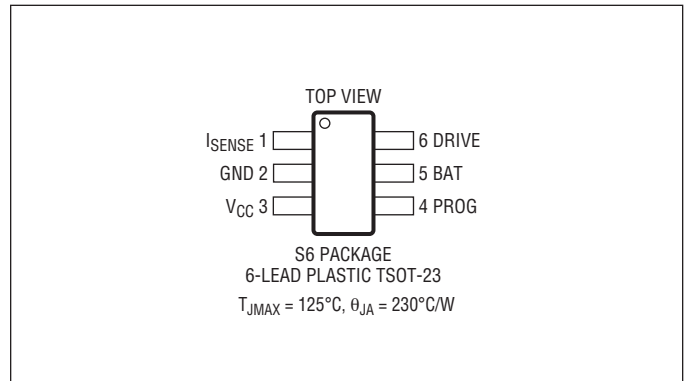

## ORDER INFORMATION

LEAD FREE FINISH	TAPE AND REEL	PART MARKING	PACKAGE DESCRIPTION	TEMPERATURE RANGE
LTC1734ES6-4.1#PBF	LTC1734ES6-4.1#TRPBF	LTHD	6-Lead Plastic SOT-23	-40°C to 85°C
LTC1734ES6-4.2#PBF	LTC1734ES6-4.2#TRPBF	LTRG	6-Lead Plastic SOT-23	-40°C to 85°C

Consult LTC Marketing for parts specified with wider operating temperature ranges.

Consult LTC Marketing for information on nonstandard lead based finish parts.

For more information on lead free part marking, go to: <http://www.linear.com/leadfree/>

For more information on tape and reel specifications, go to: <http://www.linear.com/tapeandreel/>

**ELECTRICAL CHARACTERISTICS** The ● denotes the specifications which apply over the full operating temperature range, otherwise specifications are at  $T_A = 25^{\circ}C$ .  $V_{CC} = 5V$ ,  $GND = 0V$  and  $V_{BAT}$  is equal to the float voltage unless otherwise noted. All current into a pin is positive and current out of a pin is negative. All voltages are referenced to GND, unless otherwise specified.

SYMBOL	PARAMETER	CONDITIONS	MIN	TYP	MAX	UNITS
<b><math>V_{CC}</math> Supply</b>						
$V_{CC}$	Operating Supply Range (Note 5)		●	4.55	8	V
$I_{CC}$	Quiescent $V_{CC}$ Pin Supply Current	$V_{BAT} = 5V$ , (Forces $I_{DRIVE} = I_{BAT} = 0$ ), $I_{PROG} = 200\mu A$ , (7500 $\Omega$ from PROG to GND)	●	670	1150	$\mu A$
$I_{SHDN}$	$V_{CC}$ Pin Supply Current in Manual Shutdown	PROG Pin Open	●	450	900	$\mu A$
$I_{BMS}$	Battery Drain Current in Manual Shutdown	PROG Pin Open (Note 3)	●	-1	0	1 $\mu A$
$I_{BSL}$	Battery Drain Current in Sleep Mode (Note 4)	$V_{CC} = 0V$	●	-1	0	1 $\mu A$
$V_{UVLOI}$	Undervoltage Lockout Exit Threshold	$V_{CC}$ Increasing	●	4.45	4.56	4.68 V
$V_{UVLOD}$	Undervoltage Lockout Entry Threshold	$V_{CC}$ Decreasing	●	4.30	4.41	4.53 V
$V_{UVHYS}$	Undervoltage Lockout Hysteresis	$V_{CC}$ Decreasing			150	mV

1734fa

**ELECTRICAL CHARACTERISTICS** The ● denotes the specifications which apply over the full operating temperature range, otherwise specifications are at  $T_A = 25^\circ\text{C}$ .  $V_{CC} = 5\text{V}$ ,  $\text{GND} = 0\text{V}$  and  $V_{BAT}$  is equal to the float voltage unless otherwise noted. All current into a pin is positive and current out of a pin is negative. All voltages are referenced to GND, unless otherwise specified.

SYMBOL	PARAMETER	CONDITIONS	MIN	TYP	MAX	UNITS	
<b>Charging Performance</b>							
$V_{BAT}$	Output Float Voltage in Constant Voltage Mode	4.1V Version, $I_{BAT} = 10\text{mA}$ , $4.55\text{V} \leq V_{CC} \leq 8\text{V}$ 4.2V Version, $I_{BAT} = 10\text{mA}$ , $4.55\text{V} \leq V_{CC} \leq 8\text{V}$	● ●	4.059 4.158	4.10 4.20	4.141 4.242	V V
$I_{BAT1}$	Output Full-Scale Current When Programmed for 200mA in Constant Current Mode	$R_{PROG} = 7500\Omega$ , $4.55\text{V} \leq V_{CC} \leq 8\text{V}$ , Pass PNP Beta > 50	●	155	200	240	mA
$I_{BAT2}$	Output Full-Scale Current When Programmed for 700mA in Constant Current Mode	$R_{PROG} = 2143\Omega$ , $4.55\text{V} \leq V_{CC} \leq 8\text{V}$ , Pass PNP Beta > 50	●	620	700	770	mA
$V_{CM1}$	Current Monitor Voltage on PROG Pin	$I_{BAT} = 10\%$ of $I_{BAT1}$ , $R_{PROG} = 7500\Omega$ , $4.55\text{V} \leq V_{CC} \leq 8\text{V}$ , Pass PNP Beta > 50, $0^\circ\text{C} \leq T_A \leq 85^\circ\text{C}$		0.045	0.15	0.28	V
$V_{CM2}$	Current Monitor Voltage on PROG Pin	$I_{BAT} = 10\%$ of $I_{BAT2}$ , $R_{PROG} = 2143\Omega$ , $4.55\text{V} \leq V_{CC} \leq 8\text{V}$ , Pass PNP Beta > 50, $0^\circ\text{C} \leq T_A \leq 85^\circ\text{C}$		0.10	0.15	0.20	V
$I_{DSINK}$	Drive Output Current	$V_{DRIVE} = 3.5\text{V}$	●	30			mA
<b>Charger Manual Control</b>							
$V_{MSDT}$	Manual Shutdown Threshold	$V_{PROG}$ Increasing	●	2.05	2.15	2.25	V
$V_{MSHYS}$	Manual Shutdown Hysteresis	$V_{PROG}$ Decreasing from $V_{MSDT}$			90		mV
$I_{PROGPU}$	Programming Pin Pull-Up Current	$V_{PROG} = 2.5\text{V}$		-6	-3	-1.5	$\mu\text{A}$
<b>Protection</b>							
$I_{DSHRT}$	Drive Output Short-Circuit Current Limit	$V_{DRIVE} = V_{CC}$	●	35	65	130	mA

**Note 1:** Stresses beyond those listed under Absolute Maximum Ratings may cause permanent damage to the device. Exposure to any Absolute Maximum Rating condition for extended periods may affect device reliability and lifetime.

**Note 2:** The LTC1734E is guaranteed to meet performance specifications from  $0^\circ\text{C}$  to  $70^\circ\text{C}$  ambient temperature range and  $0^\circ\text{C}$  to  $100^\circ\text{C}$  junction temperature range. Specifications over the  $-40^\circ\text{C}$  to  $85^\circ\text{C}$  operating ambient temperature range are assured by design, characterization and correlation with statistical process controls.

**Note 3:** Assumes that the external PNP pass transistor has negligible B-C reverse-leakage current when the collector is biased at 4.2V ( $V_{BAT}$ ) and the base is biased at 5V ( $V_{CC}$ ).

**Note 4:** Assumes that the external PNP pass transistor has negligible B-E reverse-leakage current when the emitter is biased at 0V ( $V_{CC}$ ) and the base is biased at 4.2V ( $V_{BAT}$ ).

**Note 5:** The 4.68V maximum undervoltage lockout (UVLO) exit threshold must first be exceeded before the minimum  $V_{CC}$  specification applies. Short duration drops below the minimum  $V_{CC}$  specification of several microseconds or less are ignored by the UVLO. If manual shutdown is entered, then  $V_{CC}$  must be higher than the 4.68V maximum UVLO threshold before manual shutdown can be exited. When operating near the minimum  $V_{CC}$ , a suitable PNP transistor with a low saturation voltage must be used.

## TYPICAL PERFORMANCE CHARACTERISTICS

**Float Voltage vs Temperature and Supply Voltage**

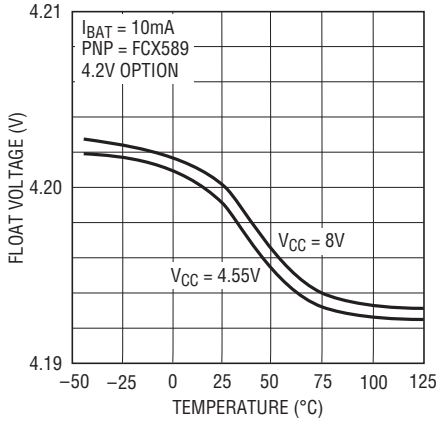

1734 G01

**Float Voltage vs IBAT**

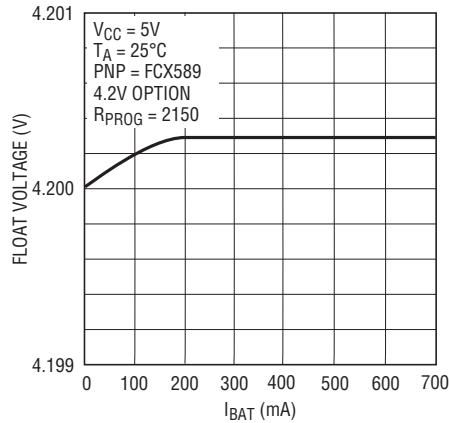

1734 G02

**IBAT1 vs Temperature and Supply Voltage**

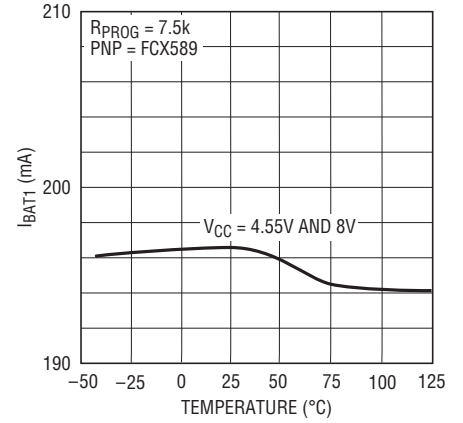

1734 G03

**IBAT2 vs Temperature and Supply Voltage**

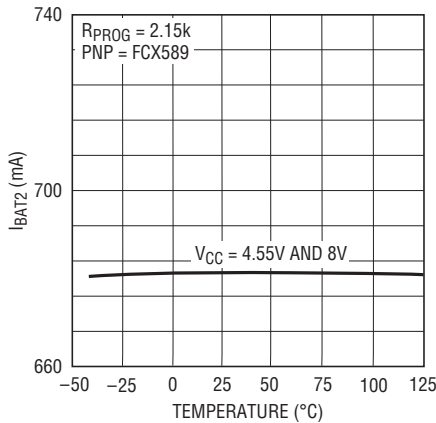

1734 G04

**IBAT1 vs VBAT**

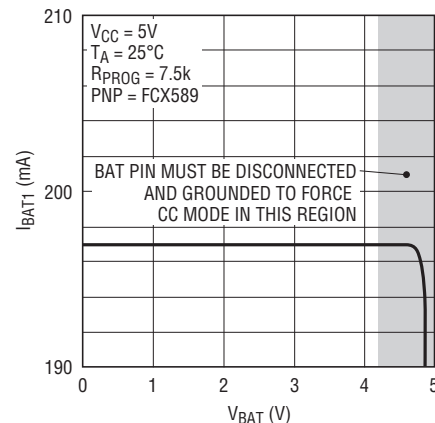

1734 G05

**IBAT2 vs VBAT**

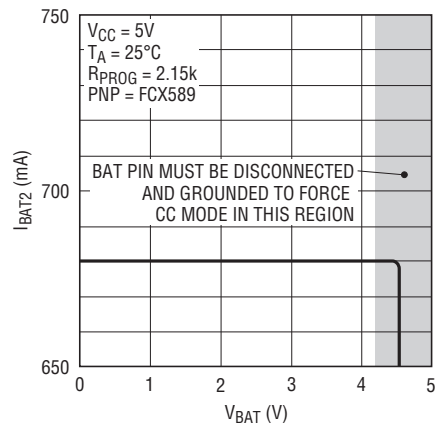

1734 G06

**Program Pin Pull-Up Current vs Temperature and Supply Voltage**

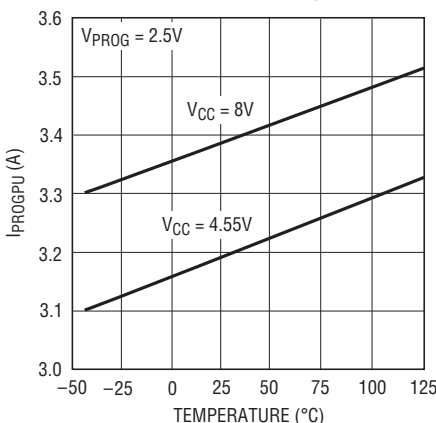

1734 G07

**Program Pin Pull-Up Current vs VPROG**

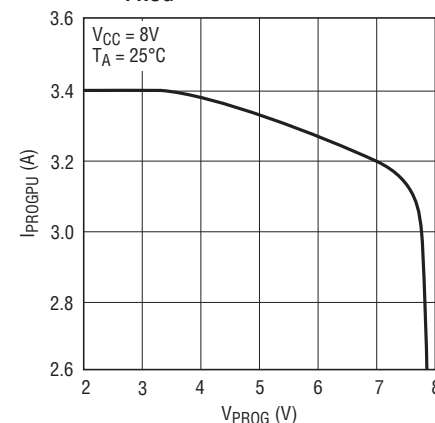

1635 G08

**Program Pin Voltage vs Charge Current (200mA)**

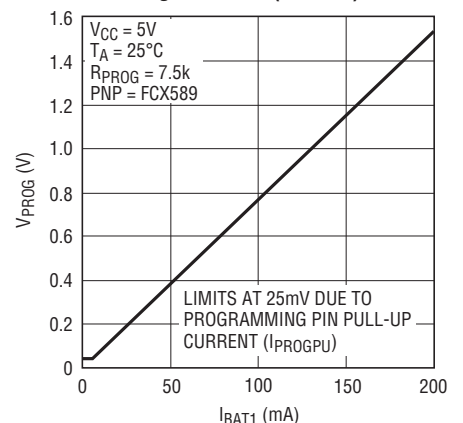

1734 F09

## TYPICAL PERFORMANCE CHARACTERISTICS

Program Pin Voltage vs Charge Current (700mA)

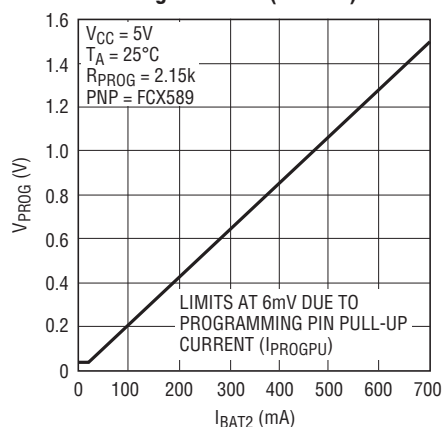

1734 G10

Program Pin Voltage for  $I_{BAT1}/10$  vs Temperature and Supply Voltage

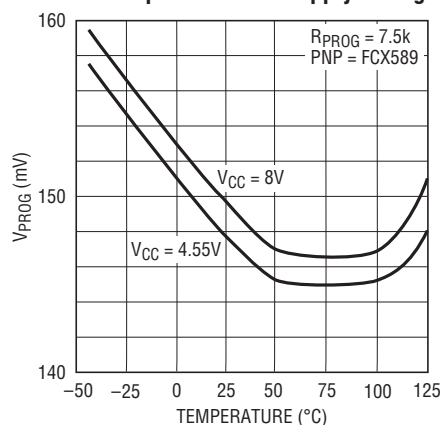

1734 G11

Program Pin Voltage for  $I_{BAT2}/10$  vs Temperature and Supply Voltage

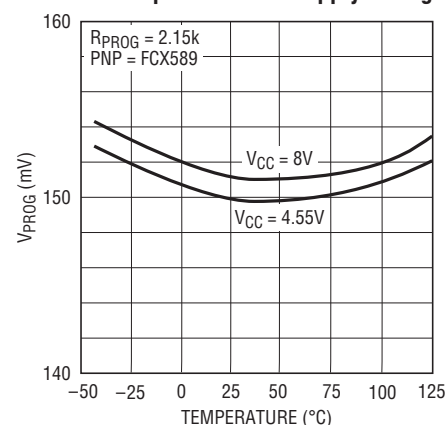

1734 G12

## PIN FUNCTIONS

**$I_{SENSE}$  (Pin 1):** Sense Node for Charge Current. Current from  $V_{CC}$  passes through the internal current sense resistor and reappears at  $I_{SENSE}$  to supply current to the external PNP emitter. The PNP collector provides charge current to the battery.

**GND (Pin 2):** Ground. Provides a reference for the internal voltage regulator and a return for all internal circuits. When in the constant voltage mode, the LTC1734 will precisely regulate the voltage between the BAT and GND pins. The battery ground should connect close to the GND pin to avoid voltage drop errors.

**$V_{CC}$  (Pin 3):** Positive Input Supply Voltage. This pin supplies power to the internal control circuitry and external PNP transistor through the internal current sense resistor. This pin should be bypassed to ground with a capacitor in the range of  $1\mu F$  to  $10\mu F$ .

**PROG (Pin 4):** Charge Current Programming, Charge Current Monitor and Manual Shutdown Pin. Provides a virtual reference voltage of 1.5V for an external resistor ( $R_{PROG}$ ) tied between this pin and ground that programs the battery charge current when the charger is in the constant current mode. The typical charge current will be 1000 times greater than the current through this resistor ( $I_{BAT}$

=  $1500/R_{PROG}$ ). This pin also allows for the charge current to be monitored. The voltage on this pin is proportional to the charge current where 1.5V corresponds to the full programmed current. Floating this pin allows an internal current source to pull the pin voltage above the shutdown threshold voltage. Because this pin is in a signal path, excessive capacitive loading can cause AC instability. See the Applications Information section for more details.

**BAT (Pin 5):** Battery Voltage Sense Input. A precision internal resistor divider sets the final float voltage on this pin. This divider is disconnected in the manual shutdown or sleep mode. When charging, approximately  $34\mu A$  flows into the BAT pin. To minimize float voltage errors, avoid excessive resistance between the battery and the BAT pin. For dynamically stable operation, this pin usually requires a minimum bypass capacitance to ground of  $5\mu F$  to frequency compensate for the high frequency inductive effects of the battery and wiring.

**DRIVE (Pin 6):** Base Drive Output for the External PNP Pass Transistor. Provides a controlled sink current that drives the base of the PNP. This pin has current limiting protection for the LTC1734.

## BLOCK DIAGRAM

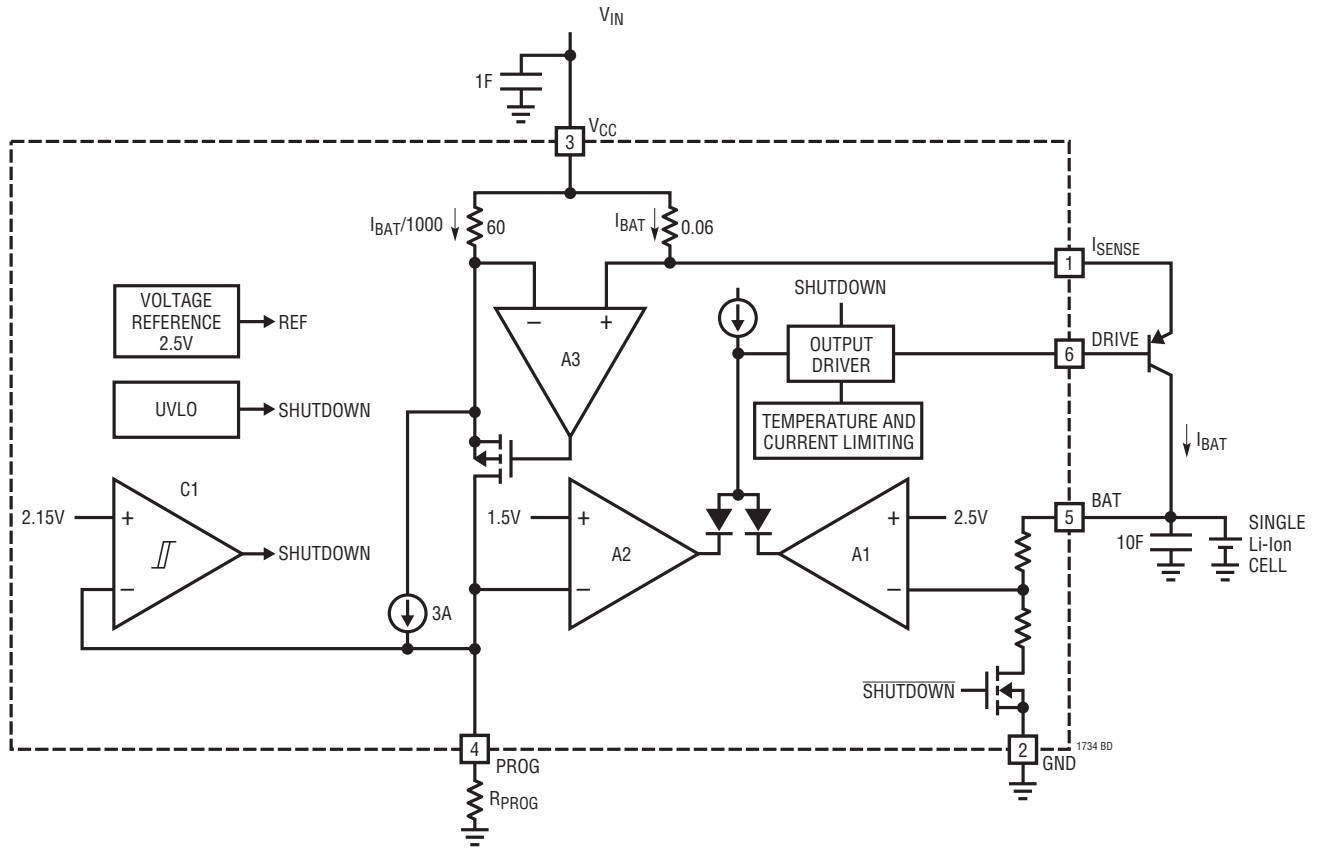

## OPERATION

The LTC1734 is a linear battery charger controller. Operation can best be understood by referring to the Block Diagram. Charging begins when  $V_{CC}$  rises above the UVLO (Undervoltage Lockout) threshold  $V_{UVLO1}$  and an external current programming resistor is connected between the PROG pin and ground. When charging, the collector of the external PNP provides the charge current. The PNP's emitter current flows through the  $I_{SENSE}$  pin and through the internal  $0.06\Omega$  current sense resistor. This current is close in magnitude, but slightly more than the collector current since it includes the base current. Amplifier A3, along with the P-channel FET, will force the same voltage that appears across the  $0.06\Omega$  resistor to appear across the internal  $60\Omega$  resistor. The scale factor of 1000:1 in resistor values will cause the FET's drain current to be 1/1000 of the charge current and it is this current that flows through the PROG pin. In the constant current mode, amplifier A2 is used to limit the charge current to the maximum that is programmed by  $R_{PROG}$ .

The PROG pin current, which is 1/1000 of the charge current, develops a voltage across the program resistor. When this voltage reaches 1.5V, amplifier A2 begins diverting current away from the output driver, thus limiting the charge current. This is the constant current mode. The constant charge current is  $1000 \cdot (1.5V/R_{PROG})$ .

As the battery accepts charge, its voltage rises. When it reaches the preset float voltage of 4.2V (LTC1734-4.2 version), a precisely divided down version of this voltage (2.5V) is compared to the 2.5V internal reference voltage by amplifier A1. If the battery voltage attempts to exceed

4.2V (2.5V at amplifier A1's input) the amplifier will divert current away from the output driver thus limiting charge current to that which will maintain 4.2V on the battery. This is the constant voltage mode.

When in the constant voltage mode, the 1000:1 current ratio is still valid and the voltage on the PROG pin will indicate the charge current as a proportion of the maximum current set by the current programming resistor. The battery charge current is  $1000 \cdot (V_{PROG}/R_{PROG})$  amps. This feature allows a microcontroller with an ADC to easily monitor charge current and if desired, manually shut down the charger at the appropriate time.

When  $V_{CC}$  is applied, the charger can be manually shut down by floating the otherwise grounded end of  $R_{PROG}$ . An internal  $3\mu A$  current source pulls the PROG pin above the 2.15V threshold of voltage comparator C1 initiating shutdown.

For charging NiMH or NiCd batteries, the LTC1734 can function as a constant current source by grounding the BAT pin. This will prevent amplifier A1 from trying to limit charging current and only A2 will control the current.

Fault conditions such as overheating of the die or excessive DRIVE pin current are monitored and limited.

When input power is removed or manual shutdown is entered, the charger will drain only tiny leakage currents from the battery, thus maximizing battery standby time. With  $V_{CC}$  removed the external PNP's base is connected to the battery by the charger. In manual shutdown the base is connected to  $V_{CC}$  by the charger.

## APPLICATIONS INFORMATION

### Charging Operation

Charging begins when an input voltage is present that exceeds the undervoltage lockout threshold ( $V_{UVLO1}$ ), a Li-Ion battery is connected to the charger output and a program resistor is connected from the PROG pin to ground. During the first portion of the charge cycle, when the battery voltage is below the preset float voltage, the charger is in the constant current mode. As the battery voltage rises and reaches the preset float voltage, the charge current begins to decrease and the constant voltage portion of the charge cycle begins. The charge current will continue to decrease exponentially as the battery approaches a fully charged condition.

Should the battery be removed during charging, a fast built-in protection circuit will prevent the BAT pin from rising above 5V, allowing the precision constant voltage circuit time to respond.

### Manual Shutdown

Floating the program resistor allows an internal  $3\mu\text{A}$  current source ( $I_{PROG}$ ) to pull the PROG pin above the 2.15V shutdown threshold ( $V_{MSDT}$ ), thus shutting down the charger. In this mode, the LTC1734 continues to draw some current from the supply ( $I_{SHDN}$ ), but only a negligible leakage current is delivered to the battery ( $I_{BMS}$ ).

Shutdown can also be accomplished by pulling the otherwise grounded end of the program resistor to a voltage greater than 2.25V ( $V_{MSDTMax}$ ). Charging will cease above 1.5V, but the internal battery voltage resistor divider will draw about  $34\mu\text{A}$  from the battery until shutdown is entered. Figure 1 illustrates a microcontroller configuration that can either float the resistor or force it to a voltage. The voltage should be no more than 8V when high and have an impedance to ground of less than 10% of the program

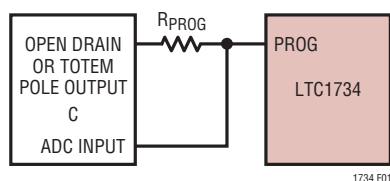

Figure 1. Interfacing with a Microcontroller

resistor value when low to prevent excessive charge current errors. To reduce errors the program resistor value may be adjusted to account for the impedance to ground. The programming resistor will prevent potentially damaging currents if the PROG pin is forced above  $V_{CC}$ . Under this condition  $V_{CC}$  may float, be loaded down by other circuitry or be shorted to ground. If  $V_{CC}$  is not shorted to ground the current through the resistor will pull  $V_{CC}$  up somewhat.

Another method is to directly switch the PROG pin to a voltage source when shutdown is desired (Caution: pulling the PROG below 1.5V with  $V_{CC}$  applied will cause excessive and uncontrolled charge currents). The voltage source must be capable of sourcing the resulting current through the program resistor. This has the advantage of not adding any error to the program resistor during normal operation. The voltage on the PROG pin must be greater than 2.25V ( $V_{MSDT(MAX)}$ ) to ensure entering shutdown, but no more than 0.3V above  $V_{CC}$  to prevent damaging the LTC1734 from excessive PROG pin current. An exception is if  $V_{CC}$  is allowed to float with no other circuitry loading  $V_{CC}$  down. Then, because the current will be low, it is allowable to have the PROG pin shutdown voltage applied. A three-state logic driver with sufficient pull-up current can be used to perform this function by enabling the high impedance state to charge or enabling the pull-up device to enter shutdown.

An NPN transistor or a diode can also be utilized to implement shutdown from a voltage source. These have the advantage of blocking current when the voltage source goes low, thus automatically disconnecting the voltage source for normal charging operation. The use of an NPN allows for use of a weak voltage source due to the current gain of the transistor. For an NPN connect the collector to  $V_{CC}$ , the base to the voltage source and the emitter to the PROG pin. For a diode, connect the anode to the voltage source and cathode to the PROG pin. An input high level ranging from 3.3V to  $V_{CC}$  should be adequate to enter shutdown while a low level of 0.5V or less should allow for normal charging operation. Use of inexpensive small signal devices such as the 2N3904 or 1N914 is recommended to prevent excessive capacitive loading on the PROG pin (see Stability section).

## APPLICATIONS INFORMATION

### Sleep Mode

When the input supply is disconnected, the IC enters the sleep mode. In this mode, the battery drain current ( $I_{BSL}$ ) is a negligible leakage current, allowing the battery to remain connected to the charger for an extended period of time without discharging the battery. The leakage current is due to the reverse-biased B-E junction of the external PNP transistor.

### Undervoltage Lockout

Undervoltage lockout (UVLO) keeps the charger off until the input voltage exceeds a predetermined threshold level ( $V_{UVLO1}$ ) that is typically 4.56V. Approximately 150mV of hysteresis is built in to prevent oscillation around the threshold level. In undervoltage lockout, battery drain current is very low ( $< 1\mu A$ ).

### Programming Constant Current

When in the constant current mode, the full-scale charge current (C) is programmed using a single external resistor between the PROG pin and ground. This charge current will be 1000 times greater than the current through the program resistor. The program resistor value is selected by dividing the voltage forced across the resistor (1.5V) by the desired resistor current.

The LTC1734 is designed for a maximum current of approximately 700mA. This translates to a maximum PROG pin current of 700 $\mu A$  and a minimum program resistor of approximately 2.1k. Because the PROG pin is in a closed-loop signal path, the pole frequency must be kept high enough to maintain adequate AC stability by avoiding excessive capacitance on the pin. See the Stability section for more details.

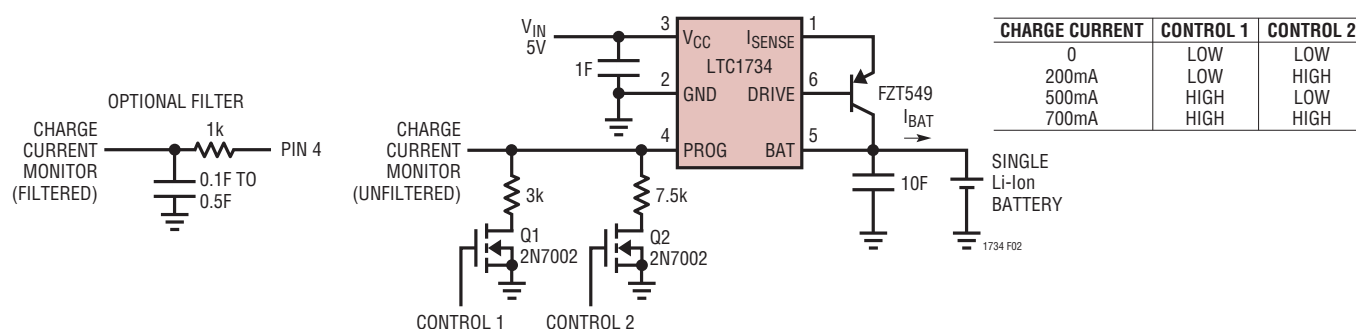

Figure 2. Logic Control Programming of Output Current to 0mA, 200mA, 500mA or 700mA

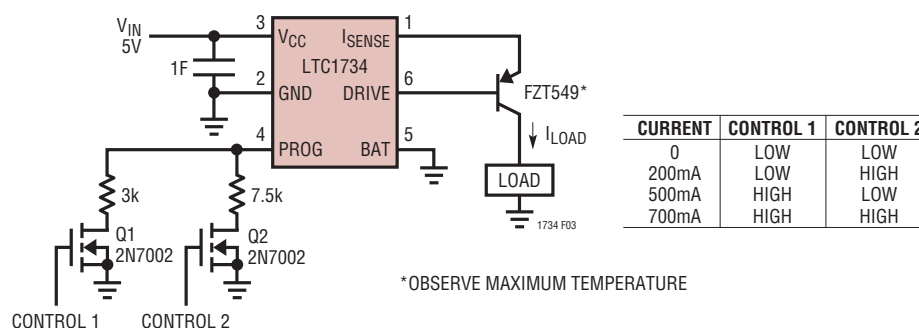

Figure 3. Programmable Current Source with Output Current of 0mA, 200mA, 500mA or 700mA

## APPLICATIONS INFORMATION

The minimum full-scale current that can be reliably programmed is approximately 50mA, which requires a program resistor of 30k. Limiting capacitive loading on the program pin becomes more important when high value program resistors are used. In addition, the current monitoring accuracy can degrade considerably at very low current levels. If current monitoring is desired, a minimum full-scale current of 200mA is recommended.

Different charge currents can be programmed by various means such as by switching in different program resistors as shown in Figures 2 and 3. A voltage DAC connected through a resistor to the PROG pin or a current DAC connected in parallel with a resistor to the PROG pin can also be used to program current (the resistor is required with the  $I_{DAC}$  to maintain AC stability as discussed in the Stability section). Another means is to use a PWM output from a microcontroller to duty cycle the charger into and out of shutdown to create an average current (see Manual Shutdown section for interfacing examples). Because chargers are generally slow to respond, it can take up to approximately 300 $\mu$ s for the charger to fully settle after a shutdown is de-asserted. This delay must be accounted for unless the minimum PWM low duration is about 3ms or more. Shutdown occurs within a few microseconds of a shutdown command. The use of PWM can extend the average current to less than the normal 200mA minimum constant current.

### Monitoring Charge Current

The voltage on the PROG pin indicates the charge current as a proportion of the maximum current set by the program resistor. The charge current is equal to  $1000 \cdot (V_{PROG}/R_{PROG})$  amps. This feature allows a microcontroller with an ADC to easily monitor charge current and if desired, manually shut down the charger at the appropriate time. See Figure 1 for an example. The minimum PROG pin current is about 3 $\mu$ A ( $I_{PROG(PU)}$ ).

Errors in the charge current monitor voltage on the PROG pin are inversely proportional to battery current and can be statistically approximated as follows:

$$\text{One Sigma Error}(\%) \cong 1 + 0.3/I_{BAT}(A)$$

Dynamic loads on the battery will cause transients to appear on the PROG pin. Should they cause excessive errors in charge current monitoring, a simple RC filter as shown in Figure 2 can be used to filter the transients. The filter will also quiet the PROG pin to help prevent inadvertent momentary entry into the manual shutdown mode.

Because the PROG pin is in a closed-loop signal path the pole frequency must be kept high enough to maintain adequate AC stability. This means that the maximum resistance and capacitance presented to the PROG pin must be limited. See the Stability section for more details.

### Constant Current Source

The LTC1734 can be used as a constant current source by disabling the voltage control loop as shown in Figure 3. This is done by pulling the BAT pin below the preset float voltages of 4.1V or 4.2V by grounding the BAT pin. The program resistor will determine the output current. The output current range can be between approximately 50mA and 700mA, depending on the maximum power rating of the external PNP pass transistor.

### External PNP Transistor

The external PNP pass transistor must have adequate beta, low saturation voltage and sufficient power dissipation capability (including any heat sinking, if required).

To provide 700mA of charge current with the minimum available base drive of approximately 30mA requires a PNP beta greater than 23. If lower beta PNP transistors are used, more base current is required from the LTC1734. This can result in the output drive current limit being reached, or thermal shutdown due to excessive power dissipation. Excessive beta can affect AC stability (see Stability section)

With low supply voltages, the PNP saturation voltage ( $V_{CESAT}$ ) becomes important. The  $V_{CESAT}$  must be less than the minimum supply voltage minus the maximum voltage drop across the internal sense resistor and bond wires (0.1 $\Omega$ ) and battery float voltage. If the PNP transistor can not achieve the low saturation voltage required, base current will dramatically increase. This is to be avoided for a number of reasons: output drive may reach current

## APPLICATIONS INFORMATION

**Table 1. PNP Pass Transistor Selection Guide**

MAXIMUM P <sub>D</sub> (W) MOUNTED ON BOARD AT T <sub>A</sub> = 25°C	PACKAGE STYLE	ZETEX PART NUMBER	ROHM PART NUMBER	COMMENTS
0.5	SOT-23	FMMT549		Low V <sub>CESAT</sub>
0.625	SOT-23	FMMT720		Very Low V <sub>CESAT</sub> , High Beta
1	SOT-89	FCX589 or BCX69		
1.1	SOT-23-6	ZXT10P12DE6		Very Low V <sub>CESAT</sub> , High Beta, Small
1 to 2	SOT-89	FCX717		Very Low V <sub>CESAT</sub> , High Beta
2	SOT-223	FZT589		Low V <sub>CESAT</sub>
2	SOT-223	BCP69 or FZT549		
0.75	FTR		2SB822	Low V <sub>CESAT</sub>
1	ATV		2SB1443	Low V <sub>CESAT</sub>
2	SOT-89		2SA1797	Low V <sub>CESAT</sub>
10 (T <sub>C</sub> = 25°C)	TO-252		2SB1182	Low V <sub>CESAT</sub> , High Beta

limit resulting in the charger's characteristics to go out of specifications, excessive power dissipation may force the IC into thermal shutdown, or the battery could become discharged because some of the current from the DRIVE pin could be pulled from the battery through the forward biased collector base junction.

For example, to program a charge current of 500mA with a minimum supply voltage of 4.75V, the minimum operating V<sub>CE</sub> is:

$$V_{CE(MIN)}(V) = 4.75 - (0.5)(0.1) - 4.2 = 0.5V$$

The actual battery charge current (I<sub>BAT</sub>) is slightly smaller than the expected charge current because the charger senses the emitter current and the battery charge current will be reduced by the base current. In terms of  $\beta$  (I<sub>C</sub>/I<sub>B</sub>), I<sub>BAT</sub> can be calculated as follows:

$$I_{BAT}(A) = 1000 \cdot I_{PROG}[\beta/(\beta + 1)]$$

If  $\beta = 50$ , then I<sub>BAT</sub> is 2% low. If desired, the 2% loss can be compensated for by increasing I<sub>PROG</sub> by 2%.

Another important factor to consider when choosing the PNP pass transistor is the power handling capability. The transistor's data sheet will usually give the maximum rated power dissipation at a given ambient temperature with a power derating for elevated temperature operation. The maximum power dissipation of the PNP when charging is:

$$P_{D(MAX)}(W) = I_{BAT} (V_{DD(MAX)} - V_{BAT(MIN)})$$

V<sub>DD(MAX)</sub> is the maximum supply voltage and V<sub>BAT(MIN)</sub> is the minimum battery voltage when discharged.

Once the maximum power dissipation and V<sub>CE(MIN)</sub> are known, Table 1 can be used as a guide in selecting some PNPs to consider. In the table, very low V<sub>CESAT</sub> is less than 0.25V, low V<sub>CESAT</sub> is 0.25V to 0.5V and the others are 0.5V to 0.8V all depending on the current. See the manufacturer's data sheet for details. All of the PNP transistors are rated to carry at least 1A continuously as long as the power dissipation is within limits. The Stability section addresses caution in the use of high beta PNPs.

Should overheating of the PNP transistor be a concern, protection can be achieved with a positive temperature coefficient (PTC) thermistor, wired in series with the current programming resistor and thermally coupled to the transistor. The PTH9C chip series from Murata has a steep resistance increase at temperature thresholds from 85°C to 145°C making it behave somewhat like a thermostat switch. For example, the model PTH9C16TBA471Q thermistor is 470Ω at 25°C, but abruptly increase its resistance to 4.7k at 125°C. Below 125°C, the device exhibits a small negative TC. The 470Ω thermistor can be added in series with a 1.6k resistor to form the current programming resistor for a 700mA charger. Should the thermistor reach 125°C, the charge current will drop to 238mA and inhibit any further increase in temperature.

## APPLICATIONS INFORMATION

### Stability

The LTC1734 contains two control loops: constant voltage and constant current. To maintain good AC stability in the constant voltage mode, a capacitor of at least 4.7μF is usually required from BAT to ground. The battery and interconnecting wires appear inductive at high frequencies, and since these are in the feedback loop, this capacitance may be necessary to compensate for the inductance. This capacitor need not exceed 100μF and its ESR can range from near zero to several ohms depending on the inductance to be compensated. In general, compensation is optimal with a capacitance of 4.7μF to 22μF and an ESR of 0.5Ω to 1.5Ω.

Using high beta PNP transistors (>300) and very low ESR output capacitors (especially ceramic) reduces the phase margin, possibly resulting in oscillation. Also, using high value capacitors with very low ESRs will reduce the phase margin. Adding a resistor of 0.5Ω to 1.5Ω in series with the capacitor will restore the phase margin.

In the constant current mode, the PROG pin is in the feedback loop, not the battery. Because of this, capacitance on this pin must be limited. Locating the program resistor near the PROG pin and isolating the charge current monitoring circuitry (if used) from the PROG pin with a 1k to 10k resistor may be necessary if the capacitance is greater than that given by the following equation:

$$C_{MAX(pF)} = \frac{400k}{R_{PROG}}$$

Higher charge currents require lower program resistor values which can tolerate more capacitive loading on the PROG pin. Maximum capacitance can be as high as 50pF for a charge current of 200mA ( $R_{PROG} = 7.5k$ ).

Figure 4 is a simple test circuit for checking stability in both the constant current and constant voltage modes. With input power applied and a near fully charged battery connected to the charger, driving the PROG pin with a pulse generator will cycle the charger in and out of the manual shutdown mode. Referring to Figure 5, after a short delay, the charger will enter the constant current mode

first, then if the battery voltage is near the programmed voltage of 4.1V or 4.2V, the constant voltage mode will begin. The resulting waveform on the PROG pin is an indication of stability.

The double exposure photo in Figure 5 shows the effects of capacitance on the program pin. The middle waveform is typical while the lower waveform indicates excessive program pin capacitance resulting in constant current mode instability. Although not common, ringing on the constant voltage portion of the waveform is an indication of instability due to any combination of extremely low ESR values, high capacitance values of the output capacitor or very high PNP transistor beta. To minimize the effect of the scope probe capacitance, a 10k resistor is used to isolate the probe from the program pin. Also, an adjustable load resistor or current sink can be used to quickly alter the charge current when a fully charged battery is used.

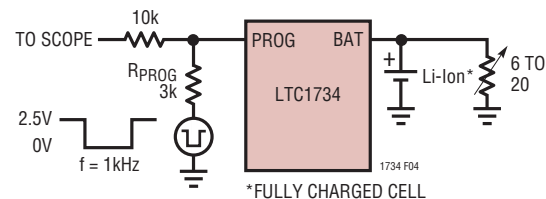

Figure 4. Setup for AC Stability Testing

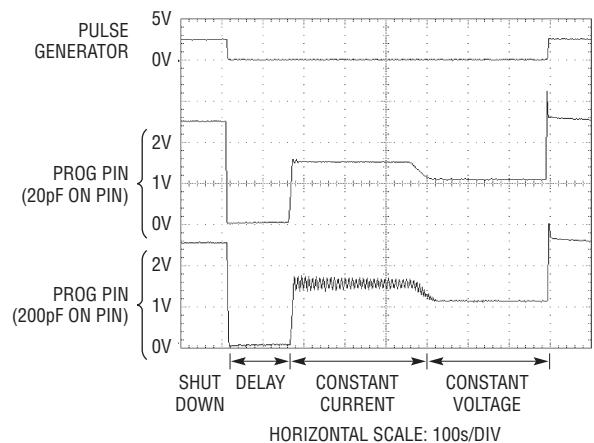

Figure 5. Stability Waveforms

## APPLICATIONS INFORMATION

### Reverse Input Voltage Protection

In some applications, protection from reverse voltage on  $V_{CC}$  is desired. If the supply voltage is high enough, a series blocking diode can be used. In other cases, where the voltage drop must be kept low, a P-channel FET as shown in Figure 6 can be used.

### $V_{CC}$ Bypass Capacitor

Many types of capacitors with values ranging from  $1\mu\text{F}$  to  $10\mu\text{F}$  located close to the LTC1734 will provide adequate input bypassing. However, caution must be exercised when using multilayer ceramic capacitors. Because of the self resonant and high Q characteristics of some types of ceramic capacitors, high voltage transients can be generated under some start-up conditions, such as connecting

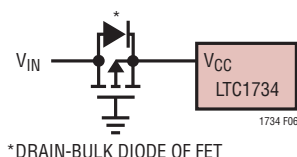

Figure 6. Low Loss Reverse Voltage Protection

the charger input to a hot power source. To prevent these transients from exceeding the absolute maximum voltage rating, several ohms of resistance can be added in series with the ceramic input capacitor.

### Internal Protection

Internal protection is provided to prevent excessive DRIVE pin currents ( $I_{DSHRT}$ ) and excessive self-heating of the LTC1734 during a fault condition. The faults can be generated from a shorted DRIVE pin or from excessive DRIVE pin current to the base of the external PNP transistor when it's in deep saturation from too low a  $V_{CE}$ . This protection is not designed to prevent overheating of the external pass transistor. Indirectly though, self-heating of the PNP thermally conducting to the LTC1734 and resulting in the IC's junction temperature to rise above  $150^{\circ}\text{C}$ , thus cutting off the PNP's base current. This action will limit the PNP's junction temperature to some temperature well above  $150^{\circ}\text{C}$ . The temperature depends on how well the IC and PNP are thermally connected and on the transistor's  $\theta_{JA}$ . See the External PNP Transistor section for information on protecting the transistor from overheating.

## PACKAGE DESCRIPTION

Please refer to <http://www.linear.com/designtools/packaging/> for the most recent package drawings.

**S6 Package**  
**6-Lead Plastic TSOT-23**  
 (Reference LTC DWG # 05-08-1636)

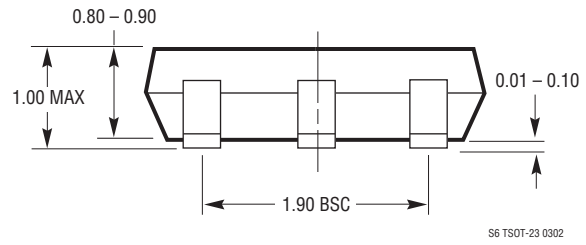
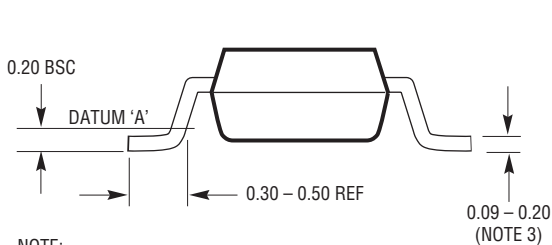
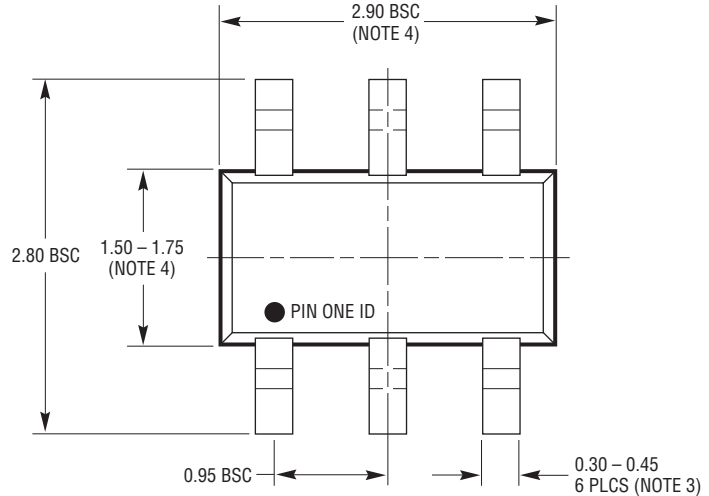
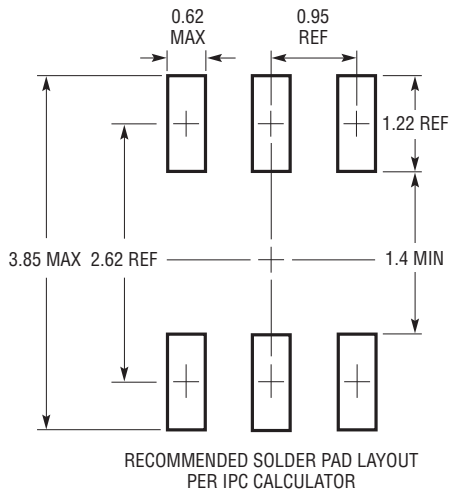

- NOTE:
1. DIMENSIONS ARE IN MILLIMETERS
  2. DRAWING NOT TO SCALE
  3. DIMENSIONS ARE INCLUSIVE OF PLATING
  4. DIMENSIONS ARE EXCLUSIVE OF MOLD FLASH AND METAL BURR
  5. MOLD FLASH SHALL NOT EXCEED 0.254mm
  6. JEDEC PACKAGE REFERENCE IS MO-193

---

## REVISION HISTORY

REV	DATE	DESCRIPTION	PAGE NUMBER
A	9/15	Revised package drawing and reference.	1, 2, 14

**RELATED PARTS**

PART NUMBER	DESCRIPTION	COMMENTS
<a href="#">LT<sup>®</sup>1510-5</a>	500kHz Constant-Current/Constant-Voltage Battery Charger	Up to 1A Charge Current for Li-Ion, NiCd, NiMH or Lead-Acid Batteries
<a href="#">LT1571-1/LT1571-2</a> <a href="#">LT1571-5</a>	200kHz/500kHz Constant-Current/Constant-Voltage Battery Charger Family	Up to 1.5A Charge Current for 1-, 2- or Multiple Cell Li-Ion Batteries, Preset and Adjustable Battery Voltages, C/10 Charge Detection
<a href="#">LTC1729</a>	Li-Ion Battery Charger Termination Controller	Can be Used with LTC Battery Chargers to Provide Charge Termination, Preset Voltages, C/10 Charge Detection and Timer Functions
<a href="#">LTC1730</a>	Li-Ion Battery Pulse Charger	Minimizes Heat Dissipation, No Blocking Diode Required, Limits Maximum Current for Safety
<a href="#">LTC1731</a>	Linear Constant-Current/Constant-Voltage Charger Controller	Simple Charger Uses External FET. Features Preset Voltages, C/10 Charge Detection and Programmable Timer
<a href="#">LTC1732</a>	Linear Constant-Current/Constant-Voltage Charger Controller	Simple Charger Uses External FET. Input Power Good Indication Features Preset Voltages, C/10 Charge Detection and Programmable Timer
<a href="#">LT1769</a>	200kHz Constant-Current/Constant-Voltage Battery Charger	Up to 2A Charge Current for Li-Ion, NiCd, NiMH or Lead-Acid Batteries with Input Current Limit